

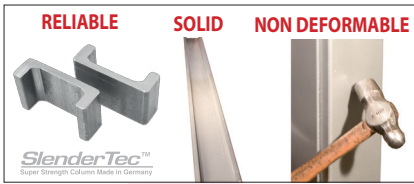

C3.5S

Ref.	kg			
13169	3.500 Kg.	660 Kg.	400/230V - 3+3kW	45"

Made in Germany



SlenderTec™
Super Strength Column Made in Germany
profile allows to manufacture extremely resistant post and less bulky.

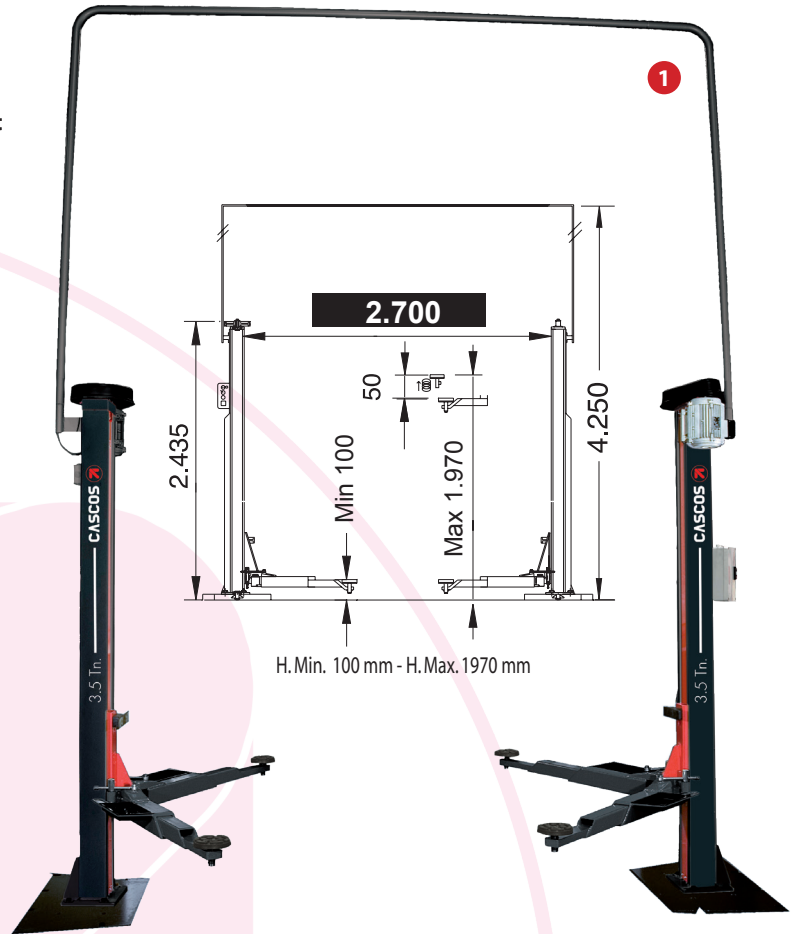
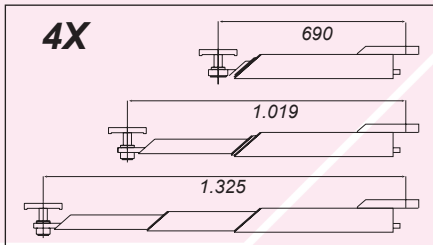
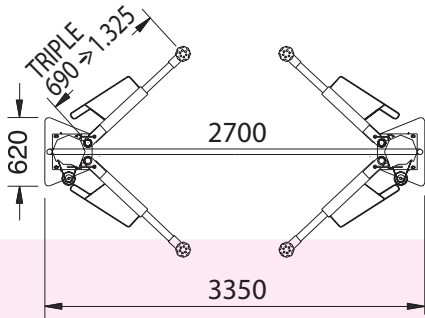

Reversibility



Our lifts include anchorage plates.

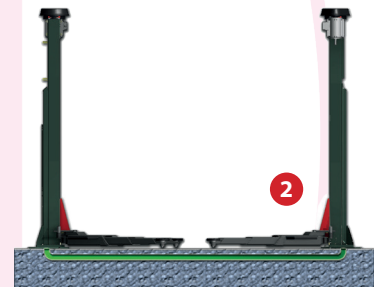

Motor wiring and detectors can go either through:

- The supplied archway 1
- The floor 2

✓ Exclusive details

Our safety locks mechanism, via spindle rod, unlike the cog type, allows universal positioning of pick-up points.

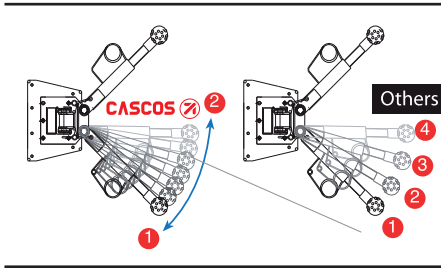

High quality guided steel bearings offer longer durability than nylon guides.

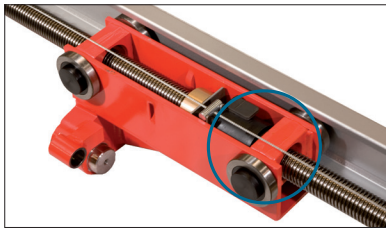

The biggest diameter spindle on the market and high quality nuts offer:

- Less wear.
- Longer lasting life.

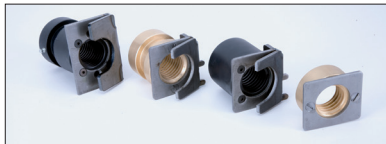

The most advance and reliable levelling system in the market



ILC SYSTEM (INTELLIGENT LIFT CONTROL)

A NEW GENERATION OF LIFTS ILC (Intelligence Lift Control) an innovative control system developed by CASCOS that not only controls the operation of lift but also allows us to display on the LCD screen control information that improves the management and performance of the equipment in many aspects: safety warnings, useful information about the lift operation, operational alerts, maintenance notifications, instructions to follow in the most common breakdowns, userconfigured options such as working height, ID key to prevent unauthorized operation, etc... ILC is a new concept that will help you control and improve the profitability of your workshop all through a friendly menu.

Maximum APPROVED load
In any position!

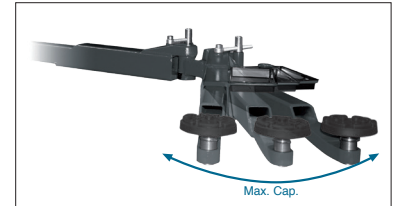
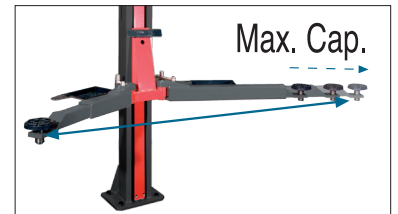

Our lifts, against the others from our main competitors, can lift the maximum load at:

- Any opening angle.
- Arm extension.



- Tool trays.
- Door protection.
- Spindle protection.

Accessories

Clip system pads

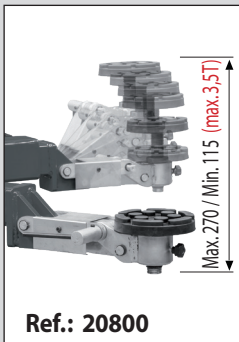

Spindles

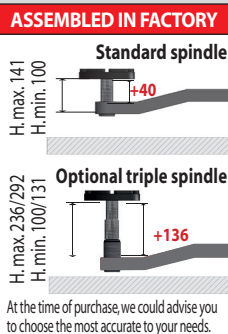

Pads Magnetic holder



Integrated power plug (Assembled in factory)



Magnetic holder for tools

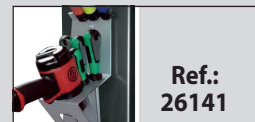

Magnetic air Kit

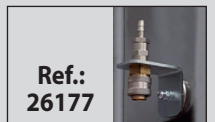

Quick pads kit

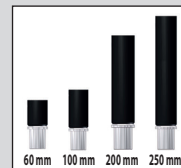

Additional buttoning opposite column



Original spare part

