



TIJERAS DE PLATAFORMA

PLATFORM SCISSORS LIFTS

PONT À CISEAUX PRISE SOUS ROUES

CASCOS



FABRICANTE EUROPEO DE ELEVADORES • EUROPEAN CAR LIFT MANUFACTURER • FABRICANT EUROPÉEN DE PONTS ÉLEVATEURS



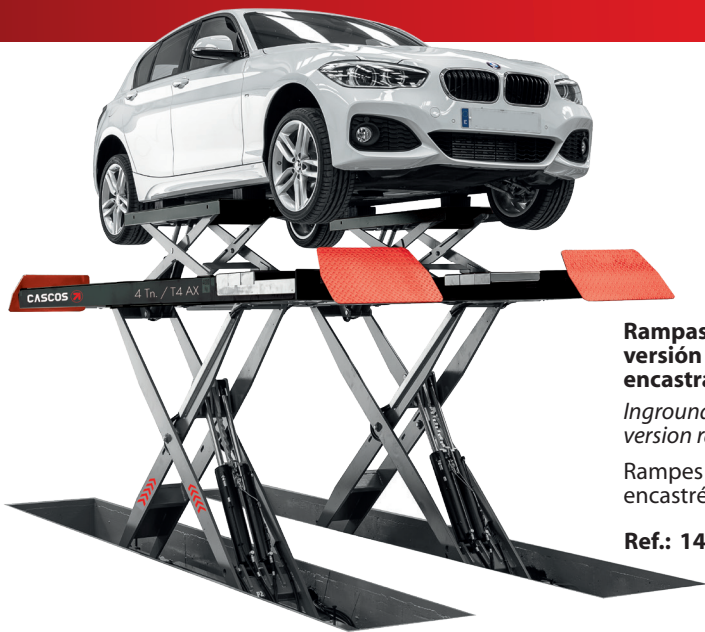

Rampas versión encastrada
Inground version ramps.
 Rampes version encastrée.
Ref.: 14987F

Rampas de superficie para elevador sobre suelo.

Surface ramps for onground lifts.
 Rampes d'accès pour version posée au sol.



T4: Ref.: 14950C
T5.5: Ref.: 14950C + 14970F

Reparabilidad garantizada por un mínimo de 10 años.
 Se asegurara el suministro de piezas durante este periodo de tiempo.

Repairable during at least 10 years.

We ensure spare parts availability during at least this period.

Réparabilité garantie pour un minimum de 10 ans.
 On assure la disponibilité de pièces détachées au moins pendant cette période de temps



Equipado de serie con bomba manual de bajada, regulador de la presión neumática y filtro separador de agua.

Includes manual descend pump, regulator of the pneumatic pressure and water filter separator.

Équipé de série avec pompe de descente manual, régulateur de pression pneumatique et d'un filtre séparateur d'eau.



Estructura y base muy robusta de llanta maciza.
Very solid structure and base "solid profiles".

Structure et embase très robuste "profilés plein".

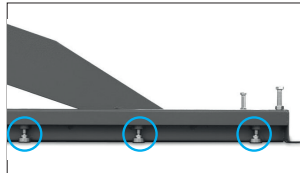

Base reforzada -150 kg.- equipada con 16 puntos de regulación.

Reinforce base of the lift -150 kg.- equipped with 16 regulation points.

Base du pont élévateur renforcée -150 kg.-, équipée avec 16 points de réglage.



Equipado con rail-guía para gato auxiliar.

Includes sliding guide for Jacking Beams.
 Equipé de série avec rail de guidage pour traverse de levage auxiliaire.

Accesorios • Accessories • Accessoires

Rampas extensibles
Extension ramp
 Extension de passerelle



T4
Ref.: 14970F
 Extensión a 2m. Para versiones T4 sobre suelo.
 Extension to 2m. For T4 versions on floor.
 Extension à 2m. Pour versions T4 posées au sol.

Kit Lingotes cerrar encastre
Recess infills kit
 Kit lingots couvre-encastre avant

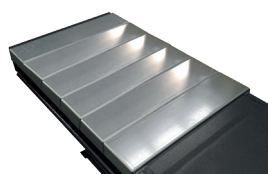

T4 **Ref.: 94345**
T5.5 **Ref.: 94346**

Kit de luz
Lighting kit
 Kit d'éclairage **Ref.: 34044**



LED 24 V
 No compatible con gato.
 No compatible with Jacking Beams.
 Pas compatible avec traverse de levage auxiliaire.

Gatos oleoneumáticos
Oleopneumatic Jacks
 Traverses oléopneumatiques

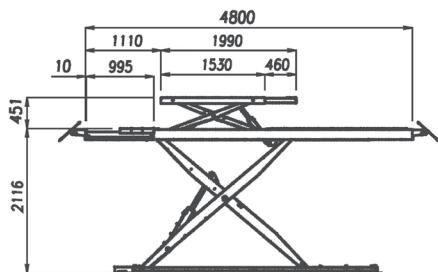
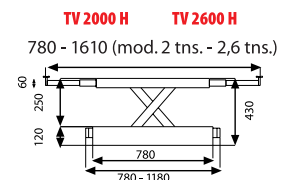

4800 mm x 660 mm x 285 mm

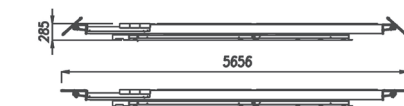

4800 mm. x 660 mm x 285 mm

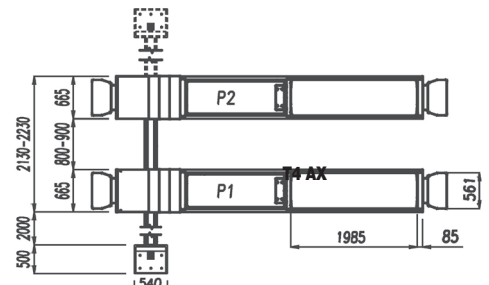

4800 mm x 660 mm x 285 mm

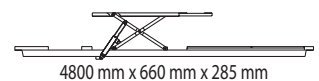

4800 mm x 660 mm x 285 mm

	T4L	T4A	T4LX	T4AX
PASARELA PLATFORM PASSERELLE	Lisa Flat Lisse	Alineación Alignment Géométrie	Lisa con auxiliar Flat, with built in lifting table Lisse avec double levage	Alineación con auxiliar Alignment, with built in lifting table Géométrie avec double levage
Ref.	140200	140209	140221	140202
Capacidad	4.000 Kg	4.000 Kg	4.000 Kg	4.000 Kg
Motor	3 HP 230/400 V. • 3 Kw 50 Hz	3 HP 230/400 V. • 3 Kw 50 Hz	3 HP 230/400 V. • 3 Kw 50 Hz	3 HP 230/400 V. • 3 Kw 50 Hz
Peso	2.060 - 2.160 Kg	2.160 - 2.260 Kg	2.360 - 2.460 Kg	2.460 - 2.560 Kg
Barra	4-8 bar	4-8 bar	4-8 bar	4-8 bar
ALUX	—	—	3,5 Tn	3,5 Tn



Opcional
Option
Optionnel

Detector de holguras hidráulico
(4 movimientos)
disponible en modelo T5.5.

Four movements hydraulic play detectors
available in model T5.5.

Plaquas à jeux hydrauliques à quatre mouvements disponible sur modèle T5.5.

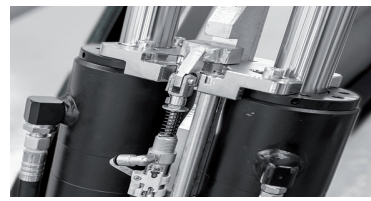

Nuevo sistema de búsqueda automática de nivel perfecto en cada diente. (A-AX-AXPD).

New automatic system searching perfect levelling in each tooth. (A-AX-AXPD).

Système de recherche automatique pour assurer même hauteur de positionnement des chemins. (A-AX-AXPD).



Elevador y auxiliar equipados con doble sistema hidráulico con 4 cilindros
(2 maestros + 2 esclavos).
Seguridad hidráulica.

Lift and built in lifting table with double hydraulic circuit.
(2 masters + 2 slaves).
Hydraulic security.

Pont élévateur avec double levage avec **double système hydraulique** à quatre vérins
(2 maîtres + 2 esclaves).
Sécurité hydraulique.

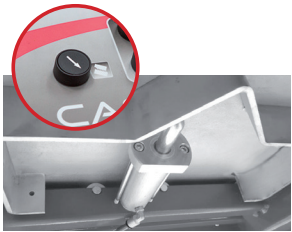

Bloqueo neumático de planchas deslizantes traseras.

Pneumatic blocking system of back slides platform.

Blocage pneumatique des plaques de grippage.

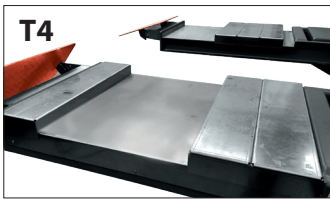

Encastre delantero equipado con lingotes de regulación móviles.

Mobile front recess through regulating trays.
Encastrement avant équipé avec cales de réglage mobiles.

T4: 3 Lingotes. 3 Trays. 3 Cales de réglage
T5.5: 4 Lingotes. 4 Trays. 4 Cales de réglage



Doble elevación con extensible.

Extending lift table.

Chemins avec double levage + extensible..

soires

Tacos de goma
Rubber pads
Tampons caoutchouc

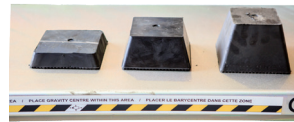

Ref.: 51001 Ref.: 51002 Ref.: 51003
30 mm. 70 mm. 100 mm.

Kit amortiguadores
Set of shock absorbers
Kit d'amortisseurs

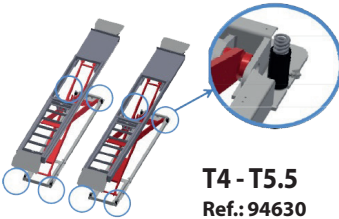

T4 - T5.5
Ref.: 94630

Kit latiguillos
Hose kit
Kit de rallonge des flexibles



Se suministran con consola a la izquierda. Existen kits para: cambiar la ubicación de la consola o prolongar las distancias de serie (2m - ver planos).

Supplied with console to the left. Available kits to: change the location of the console or extend standard distances: 2m - see the plans.

Pupitre positionné à gauche, de série. Des kits sont disponibles pour modifier l'emplacement du pupitre ou prolonger la distance de série (2m - voir les plans).

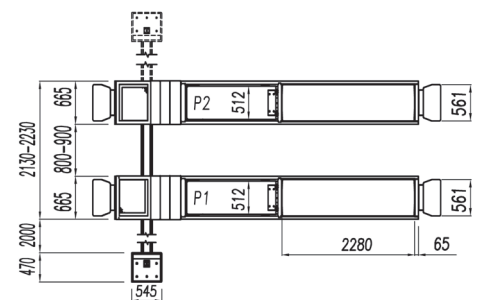
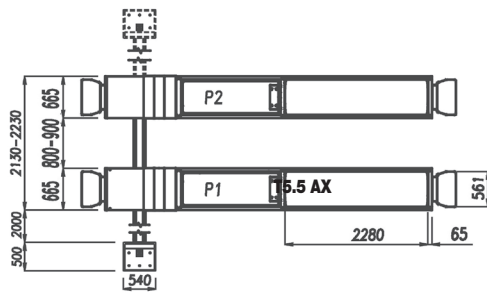
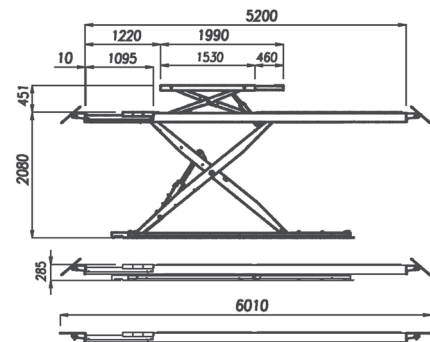
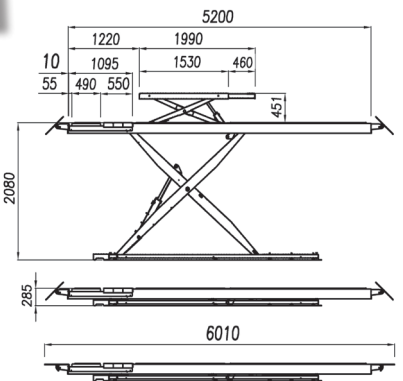

T5.5 AXPD

5200 mm x 660 mm x 285 mm	5200 mm x 660 mm x 285 mm	5200 mm x 660 mm x 285 mm	5200 mm x 660 mm x 285 mm	5200 mm x 660 mm x 285 mm	5200 mm x 660 mm x 285 mm
T5.5L	T5.5A	T5.5LX	T5.5AX	T5.5LXPD	T5.5AXPD
Lisa Flat Lisse	Alineación Alignment Géométrie	Lisa con auxiliar Flat, with built in lifting table Lisse avec double levage	Alineación con auxiliar Alignment, with built in lifting table Géométrie avec double levage	Lisa-auxiliar-detector holguras Flat-double lift-play detector Lisse-double levage-plaques à jeux	Alineación-auxiliar-detector holguras Alignment-double lift-play detector Géométrie-double levage-plaques à jeux
140222	140225	140229	140226	140227	140228
5.500 Kg	5.500 Kg	5.500 Kg	5.500 Kg	5.500 Kg	5.500 Kg
3 HP 230/400 V. • 3 Kw 50 Hz	3 HP 230/400 V. • 3 Kw 50 Hz	3 HP 230/400 V. • 3 Kw 50 Hz	3 HP 230/400 V. • 3 Kw 50 Hz	3 HP 230/400 V. • 3 Kw 50 Hz	3 HP 230/400 V. • 3 Kw 50 Hz
2.560 - 2.660 Kg	2.660 - 2.760 Kg	2.860 - 2.960 Kg	2.860 - 2.960 Kg	2.700 - 3.100 Kg	3.060 - 3.150 Kg
4-8 bar	4-8 bar	4-8 bar	4-8 bar	4-8 bar	4-8 bar
-	-	3,5 Tn	3,5 Tn	3,5 Tn	3,5 Tn

Homologaciones / Approvals / Homologations



CASCOS

www.cascos.es



ESPAÑA

C/ Zurrupitieta, 8 / Pol. Ind. Júndiz
Teléfono 945 290 294 / Fax 945 290 055
Vitoria-Gasteiz (Spain)
e-mail: info@cascos.es

FRANCE

Cascos Lift France
Phone + 33 781 170 361
54000 Nancy (France)
e-mail: c.stein@cascos.es



2006/42/CE & EN - 1493:2011
European Directives
& Approved Standards



CASCOS MAQUINARIA SE RESERVA EL DERECHO DE REALIZAR MODIFICACIONES TÉCNICAS SIN PREVIO AVISO
THE PLANS AND PHOTOGRAPHS SHOWN IN THIS BROCHURE ARE FOR ILLUSTRATIVE PURPOSES ONLY, AND CM RESERVES THE RIGHT FROM TIME TO TIME TO MAKE MODIFICATIONS.
PHOTOS ET DESSINS NON CONTRACTUELS